

**Logic level TOPFET  
SMD version of BUK104-50L/S**

**BUK114-50L/S**

**DESCRIPTION**

Monolithic temperature and overload protected logic level power MOSFET in a 5 pin surface mounting plastic envelope, intended as a general purpose switch for automotive systems and other applications.

**APPLICATIONS**

- General controller for driving
- lamps
  - motors
  - solenoids
  - heaters

**FEATURES**

- Vertical power DMOS output stage
- Low on-state resistance
- Logic and protection supply from separate pin
- Low operating supply current
- Overload protection against over temperature
- Overload protection against short circuit load
- Latched overload protection reset by protection supply
- Protection circuit condition indicated by flag pin
- 5 V logic compatible input level
- Separate input pin for higher frequency drive
- ESD protection on input, flag and protection supply pins
- Over voltage clamping for turn off of inductive loads
- Both linear and switching operation are possible

**QUICK REFERENCE DATA**

SYMBOL	PARAMETER	MAX.	UNIT
$V_{DS}$	Continuous drain source voltage	50	V
$I_D$	Continuous drain current	15	A
$P_{tot}$	Total power dissipation	40	W
$T_j$	Continuous junction temperature	150	°C
$R_{DS(ON)}$	Drain-source on-state resistance		
	$V_{IS} = 5\text{ V}$	125	mΩ
	$V_{IS} = 7\text{ V}$	100	mΩ
SYMBOL	PARAMETER	NOM.	UNIT
$V_{PSN}$	Protection supply voltage		
	<b>BUK114-50L</b>	5	V
	<b>BUK114-50S</b>	10	V

**FUNCTIONAL BLOCK DIAGRAM**

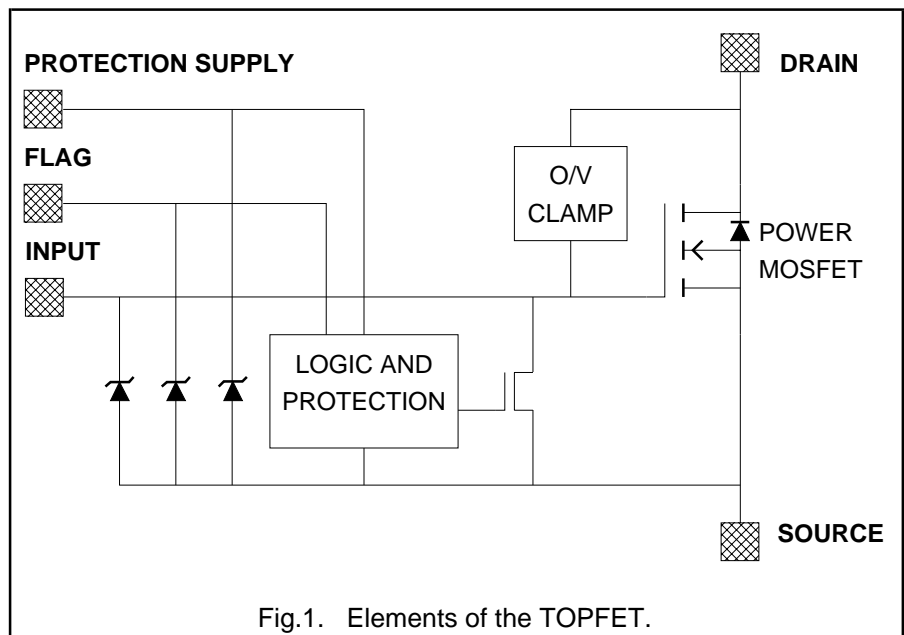

**PINNING - SOT426**

PIN	DESCRIPTION
1	input
2	flag
3	(connected to mb)
4	protection supply
5	source
mb	drain

**PIN CONFIGURATION**

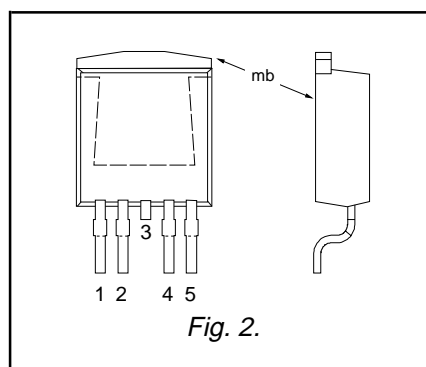

**SYMBOL**

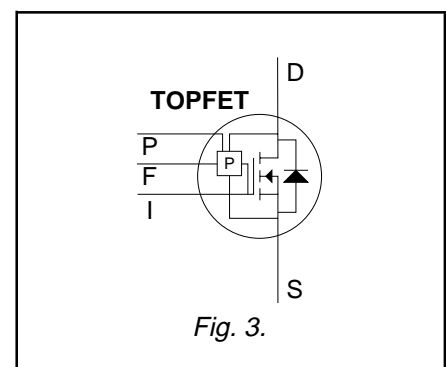

# Logic level TOPFET

## SMD version of BUK104-50L/S

BUK114-50L/S

### LIMITING VALUES

Limiting values in accordance with the Absolute Maximum Rating System (IEC 134)

SYMBOL	PARAMETER	CONDITIONS	MIN.		MAX.	UNIT	
$V_{DSS}$	<b>Voltages</b> Continuous off-state drain source voltage <sup>1</sup>	$V_{IS} = 0\text{ V}$	-		50	V	
$V_{IS}$	Continuous input voltage	-	0		11	V	
$V_{FS}$	Continuous flag voltage	-	0		11	V	
$V_{PS}$	Continuous supply voltage	-	0		11	V	
	<b>Currents</b>		$V_{IS} =$				
$I_D$	Continuous drain current	$T_{mb} \leq 25\text{ °C}$	-		7	5	V
$I_D$	Continuous drain current	$T_{mb} \leq 100\text{ °C}$	-		15	13	A
$I_{DRM}$	Repetitive peak on-state drain current	$T_{mb} \leq 25\text{ °C}$	-		9.5	8.5	A
	<b>Thermal</b>						
$P_{tot}$	Total power dissipation	$T_{mb} = 25\text{ °C}$	-		40		W
$T_{stg}$	Storage temperature	-	-55		150		°C
$T_j$	Junction temperature <sup>2</sup>	continuous	-		150		°C
$T_{sold}$	Lead temperature	during soldering	-		250		°C

### OVERLOAD PROTECTION LIMITING VALUES

With the protection supply connected, TOPFET can protect itself from two types of overload - over temperature and short circuit load.

An n-MOS transistor turns on between the input and source to quickly discharge the power MOSFET gate capacitance.

For internal overload protection to remain latched while the control circuit is high, external series input resistance must be provided. Refer to INPUT CHARACTERISTICS.

SYMBOL	PARAMETER	CONDITIONS	MIN.		MAX.	UNIT
$V_{PSP}$	Protection supply voltage <sup>3</sup>	$V_{IS} =$ for valid protection	7	5	-	V
		<b>BUK114-50L</b>	4.4	4	-	V
		<b>BUK114-50S</b>	5.4	5	-	V
$V_{DDP(T)}$	<b>Over temperature protection</b> Protected drain source supply voltage	$V_{PS} = V_{PSN}$ $V_{IS} = 10\text{ V}; R_I \geq 2\text{ k}\Omega$ $V_{IS} = 5\text{ V}; R_I \geq 1\text{ k}\Omega$	-		50	V
			-		50	V
$V_{DDP(P)}$	<b>Short circuit load protection</b> Protected drain source supply voltage <sup>4</sup>	$V_{PS} = V_{PSN}; L \leq 10\text{ }\mu\text{H}$ $V_{IS} = 10\text{ V}; R_I \geq 2\text{ k}\Omega$ $V_{IS} = 5\text{ V}; R_I \geq 1\text{ k}\Omega$	-		25	V
			-		45	V
$P_{DSM}$	Instantaneous overload dissipation		-		0.8	kW

### ESD LIMITING VALUE

SYMBOL	PARAMETER	CONDITIONS	MIN.	MAX.	UNIT
$V_C$	Electrostatic discharge capacitor voltage	Human body model; $C = 250\text{ pF}; R = 1.5\text{ k}\Omega$	-	2	kV

1 Prior to the onset of overvoltage clamping. For voltages above this value, safe operation is limited by the overvoltage clamping energy.

2 A higher  $T_j$  is allowed as an overload condition but at the threshold  $T_{j(TO)}$  the over temperature trip operates to protect the switch.

3 The minimum supply voltage required for correct operation of the overload protection circuits.

4 The device is able to self-protect against a short circuit load providing the drain-source supply voltage does not exceed  $V_{DDP(P)}$  maximum. For further information, refer to OVERLOAD PROTECTION CHARACTERISTICS.

## Logic level TOPFET SMD version of BUK104-50L/S

BUK114-50L/S

### OVERVOLTAGE CLAMPING LIMITING VALUES

At a drain source voltage above 50 V the power MOSFET is actively turned on to clamp overvoltage transients.

SYMBOL	PARAMETER	CONDITIONS	MIN.	MAX.	UNIT
$I_{DRRM}$	Repetitive peak clamping drain current	$R_{IS} \geq 100 \Omega^1$	-	15	A
$E_{DSM}$	Non-repetitive inductive turn-off energy <sup>2</sup>	$I_{DM} = 15 \text{ A}; R_{IS} \geq 100 \Omega$	-	200	mJ
$E_{DRM}$	Repetitive inductive turn-off energy	$R_{IS} \geq 100 \Omega; T_{mb} \leq 95 \text{ }^\circ\text{C};$ $I_{DM} = 4 \text{ A}; V_{DD} \leq 20 \text{ V};$ $f = 250 \text{ Hz}$	-	20	mJ
$I_{DIRM}$	Repetitive peak drain to input current <sup>3</sup>	$R_{IS} = 0 \Omega; t_p \leq 1 \text{ ms}$	-	50	mA

### REVERSE DIODE LIMITING VALUE

SYMBOL	PARAMETER	CONDITIONS	MIN.	MAX.	UNIT
$I_S$	Continuous forward current	$T_{mb} = 25 \text{ }^\circ\text{C};$ $V_{IS} = V_{PS} = V_{FS} = 0 \text{ V}$	-	15	A

### THERMAL CHARACTERISTIC

SYMBOL	PARAMETER	CONDITIONS	MIN.	TYP.	MAX.	UNIT
$R_{th \text{ j-mb}}$	Thermal resistance Junction to mounting base	-	-	2.5	3.1	K/W

### STATIC CHARACTERISTICS

$T_{mb} = 25 \text{ }^\circ\text{C}$  unless otherwise specified

SYMBOL	PARAMETER	CONDITIONS	MIN.	TYP.	MAX.	UNIT
$V_{(CL)DSR}$	Drain-source clamping voltage	$R_{IS} = 100 \Omega; I_D = 10 \text{ mA}$	50	-	65	V
$V_{(CL)DSR}$	Drain-source clamping voltage	$R_{IS} = 100 \Omega; I_{DM} = 1 \text{ A}; t_p \leq 300 \mu\text{s};$ $\delta \leq 0.01$	50	-	70	V
$I_{DSS}$	Zero input voltage drain current	$V_{DS} = 12 \text{ V}; V_{IS} = 0 \text{ V}$	-	0.5	10	$\mu\text{A}$
$I_{DSR}$	Drain source leakage current	$V_{DS} = 50 \text{ V}; R_{IS} = 100 \Omega;$	-	1	20	$\mu\text{A}$
$I_{DSR}$	Drain source leakage current	$V_{DS} = 40 \text{ V}; R_{IS} = 100 \Omega;$ $T_j = 125 \text{ }^\circ\text{C}$	-	10	100	$\mu\text{A}$
$R_{DS(ON)}$	Drain-source on-state resistance	$I_{DM} = 7.5 \text{ A};$ $t_p \leq 300 \mu\text{s}; \delta \leq 0.01$	-	75	100	m $\Omega$
		$V_{IS} = 7 \text{ V}$ $V_{IS} = 5 \text{ V}$	-	95	125	m $\Omega$

1 The input pin must be connected to the source pin by a specified external resistance to allow the power MOSFET gate source voltage to become sufficiently positive for active clamping. Refer to INPUT CHARACTERISTICS.

2 While the protection supply voltage is connected, during overvoltage clamping it is possible that the overload protection may operate at energies close to the limiting value. Refer to OVERLOAD PROTECTION CHARACTERISTICS.

3 Shorting the input to source with low resistance inhibits the internal overvoltage protection by preventing the power MOSFET gate source voltage becoming positive.

# Logic level TOPFET

## SMD version of BUK104-50L/S

BUK114-50L/S

### OVERLOAD PROTECTION CHARACTERISTICS

With adequate protection supply voltage TOPFET detects when one of the overload thresholds is exceeded.

Provided there is adequate input series resistance it switches off and remains latched off until reset by the protection supply pin.

Refer also to OVERLOAD PROTECTION LIMITING VALUES and INPUT CHARACTERISTICS.

SYMBOL	PARAMETER	CONDITIONS	MIN.	TYP.	MAX.	UNIT
$E_{DS(TO)}$	Short circuit load protection <sup>1</sup> Overload threshold energy	$V_{PS} = V_{PSN}^2$ ; $T_{mb} = 25\text{ °C}$ ; $L \leq 10\ \mu\text{H}$ ; $R_1 \geq 2\ \text{k}\Omega$	-	150	-	mJ
$t_{d\ sc}$	Response time	$V_{DD} = 13\ \text{V}$ ; $V_{IS} = 10\ \text{V}$ $V_{DD} = 13\ \text{V}$ ; $V_{IS} = 10\ \text{V}$	-	375	-	$\mu\text{s}$
$T_{j(TO)}$	Over temperature protection Threshold junction temperature	$V_{PS} = V_{PSN}$ ; $R_1 \geq 2\ \text{k}\Omega$ from $I_D \geq 0.65\ \text{A}^3$	150	-	-	$^{\circ}\text{C}$

### TRANSFER CHARACTERISTICS

$T_{mb} = 25\text{ °C}$

SYMBOL	PARAMETER	CONDITIONS	MIN.	TYP.	MAX.	UNIT
$g_{fs}$	Forward transconductance	$V_{DS} = 10\ \text{V}$ ; $I_{DM} = 7.5\ \text{A}$ $t_p \leq 300\ \mu\text{s}$ ; $\delta \leq 0.01$	5	9	-	S
$I_D$	Drain current <sup>4</sup>	$V_{DS} = 13\ \text{V}$ ; $V_{IS} = 5\ \text{V}$ $V_{IS} = 10\ \text{V}$	-	25 40	-	A A

### PROTECTION SUPPLY CHARACTERISTICS

$T_{mb} = 25\text{ °C}$  unless otherwise specified

SYMBOL	PARAMETER	CONDITIONS	MIN.	TYP.	MAX.	UNIT
$I_{PS}$ , $I_{PSL}$	Protection supply Protection supply current	normal operation or protection latched <b>BUK114-50L</b> $V_{PS} = 5\ \text{V}$ <b>BUK114-50S</b> $V_{PS} = 10\ \text{V}$	-	0.2 0.4	0.35 1.0	mA mA
$V_{PSR}$	Protection reset voltage <sup>5</sup>	$T_j = 150\text{ °C}$	1.5 1.0	2.5 -	3.5 -	V V
$V_{(CL)PS}$	Protection clamp voltage	$I_p = 1.35\ \text{mA}$	11	13	-	V

### REVERSE DIODE CHARACTERISTICS

$T_{mb} = 25\text{ °C}$

SYMBOL	PARAMETER	CONDITIONS	MIN.	TYP.	MAX.	UNIT
$V_{SDS}$	Forward voltage	$I_S = 15\ \text{A}$ ; $V_{IS} = V_{PS} = V_{FS} = 0\ \text{V}$ ; $t_p = 300\ \mu\text{s}$	-	1.0	1.5	V
$t_{rr}$	Reverse recovery time	not applicable <sup>6</sup>	-	-	-	-

1 The short circuit load protection is able to save the device providing the instantaneous on-state dissipation is less than the limiting value for  $P_{DSM}$ , which is always the case when  $V_{DS}$  is less than  $V_{DSP}$  maximum.

2 At the appropriate nominal protection supply voltage for each type. Refer to QUICK REFERENCE DATA.

3 The over temperature protection feature requires a minimum on-state drain source voltage for correct operation. The specified minimum  $I_D$  ensures this condition.

4 During overload condition. Refer also to OVERLOAD PROTECTION LIMITING VALUES and CHARACTERISTICS.

5 The supply voltage below which the overload protection circuits will be reset.

6 The reverse diode of this type is not intended for applications requiring fast reverse recovery.

# Logic level TOPFET

## SMD version of BUK104-50L/S

BUK114-50L/S

### INPUT CHARACTERISTICS

 $T_{mb} = 25\text{ °C}$  unless otherwise specified

SYMBOL	PARAMETER	CONDITIONS	MIN.	TYP.	MAX.	UNIT
$V_{IS(TO)}$ $I_{IS}$ $V_{(CL)IS}$	<b>Normal operation</b>					
	Input threshold voltage	$V_{DS} = 5\text{ V}; I_D = 1\text{ mA}$ $T_{mb} = 150\text{ °C}$	1.0 0.5	1.5 -	2.0 -	V V
	Input current Input clamp voltage	$V_{IS} = 10\text{ V}$ $I_I = 1\text{ mA}$	- 11	10 13	100 -	nA V
$R_{ISL}$	<b>Overload protection latched</b> Input resistance <sup>1</sup>	$V_{PS} = 5\text{ V}$	-	55	-	$\Omega$
			-	95	-	$\Omega$
		$V_{PS} = 10\text{ V}$	-	35	-	$\Omega$
			-	60	-	$\Omega$
$R_{IS}$ $R_I$	<b>Application information</b> External input resistances for internal overvoltage clamping <sup>2</sup> internal overload protection <sup>3</sup>	(see figure 29) $R_I = \infty\ \Omega;$ $V_{DS} > 30\text{ V}$	100	-	-	$\Omega$
		$R_{IS} = \infty\ \Omega;$ $V_{II} = 5\text{ V}$ $V_{II} = 10\text{ V}$	1 2	- -	- -	k $\Omega$ k $\Omega$

### SWITCHING CHARACTERISTICS

 $T_{mb} = 25\text{ °C}; R_I = 50\ \Omega; R_{IS} = 50\ \Omega$  (see figure 29); resistive load  $R_L = 10\ \Omega$ . For waveforms see figure 28.

SYMBOL	PARAMETER	CONDITIONS	MIN.	TYP.	MAX.	UNIT
$t_{d\ on}$	Turn-on delay time	$V_{DD} = 15\text{ V}; V_{IS}: 0\text{ V} \Rightarrow 10\text{ V}$	-	8	-	ns
$t_r$	Rise time		-	13	-	ns
$t_{d\ off}$	Turn-off delay time	$V_{DD} = 15\text{ V}; V_{IS}: 10\text{ V} \Rightarrow 0\text{ V}$	-	100	-	ns
$t_f$	Fall time		-	45	-	ns

### CAPACITANCES

 $T_{mb} = 25\text{ °C}; f = 1\text{ MHz}$ 

SYMBOL	PARAMETER	CONDITIONS	MIN.	TYP.	MAX.	UNIT
$C_{ISS}$	Input capacitance	$V_{DS} = 25\text{ V}; V_{IS} = 0\text{ V}$	-	415	600	pF
$C_{OSS}$	Output capacitance	$V_{DS} = 25\text{ V}; V_{IS} = 0\text{ V}$	-	275	400	pF
$C_{RSS}$	Reverse transfer capacitance	$V_{DS} = 25\text{ V}; V_{IS} = 0\text{ V}$	-	55	80	pF
$C_{PSO}$	Protection supply pin capacitance	$V_{PS} = 10\text{ V}$	-	30	-	pF
$C_{FSO}$	Flag pin capacitance	$V_{FS} = 10\text{ V}; V_{PS} = 0\text{ V}$	-	20	-	pF

1 The resistance of the internal transistor which discharges the power MOSFET gate capacitance when overload protection operates.

The external drive circuit should be such that the input voltage does not exceed  $V_{IS(TO)}$  minimum when the overload protection has operated. Refer also to figure for latched input characteristics.

2 Applications using a lower value for  $R_{IS}$  would require external overvoltage protection.

3 For applications requiring a lower value for  $R_I$ , an external overload protection strategy is possible using the flag pin to 'tell' the control circuit to switch off the input.

## Logic level TOPFET SMD version of BUK104-50L/S

BUK114-50L/S

### FLAG DESCRIPTION

The flag pin provides a means to detect the presence of the protection supply and indicate the state of the overload detectors. The flag is the open drain of an n-MOS transistor and requires an external pull-up resistor<sup>1</sup>. It is suitable for both 5 V and 10 V logic. Flag may be used to implement an external protection strategy<sup>2</sup> for applications which require low input drive impedance.

### TRUTH TABLE

CONDITION	DESCRIPTION	FLAG
NORMAL	Normal operation and adequate protection supply voltage	LOGIC LOW
OVER TEMP.	Over temperature detected	LOGIC HIGH
SHORT CIRCUIT	Overload condition detected	LOGIC HIGH
SUPPLY FAULT	Inadequate protection supply voltage	LOGIC HIGH

### FLAG CHARACTERISTICS

$T_{mb} = 25\text{ }^{\circ}\text{C}$  unless otherwise stated

SYMBOL	PARAMETER	CONDITIONS	MIN.	TYP.	MAX.	UNIT
$V_{FS}$ $I_{FSS}$	<b>Flag 'low'</b> Flag voltage Flag saturation current	normal operation $I_F = 1.6\text{ mA}$ $V_{FS} = 10\text{ V}$	-	0.15 15	0.4 -	V mA
$I_{FS}$ $V_{PSF}$	<b>Flag 'high'</b> Flag leakage current Protection supply threshold voltage	overload or fault $V_{FS} = 10\text{ V}$ $V_{FF} = 5\text{ V}; R_F = 3\text{ k}\Omega$ ; <b>BUK114-50L</b> <b>BUK114-50S</b>	-	-	10	$\mu\text{A}$ V V
$V_{(CL)FS}$	Flag clamping voltage	$I_F = 1\text{ mA}; V_{PS} = 0\text{ V}$	11	13	-	V
$R_F$	<b>Application information</b> Suitable external pull-up resistance	$V_{FF} = 5\text{ V}$ $V_{FF} = 10\text{ V}$	1 2	10 20	50 100	k $\Omega$ k $\Omega$

<sup>1</sup> Even if the flag pin is not used, it is recommended that it is connected to the protection supply via a pull-up resistor. It should not be left floating.

<sup>2</sup> Low pass filtering of the flag signal may be advisable to prevent false tripping.

Logic level TOPFET  
SMD version of BUK104-50L/S

BUK114-50L/S

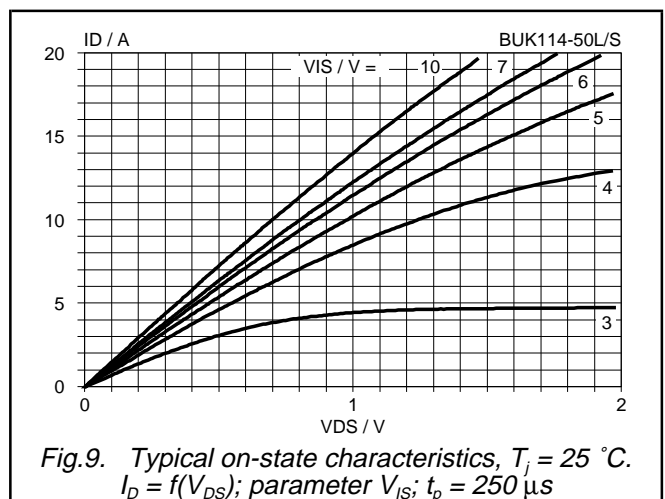
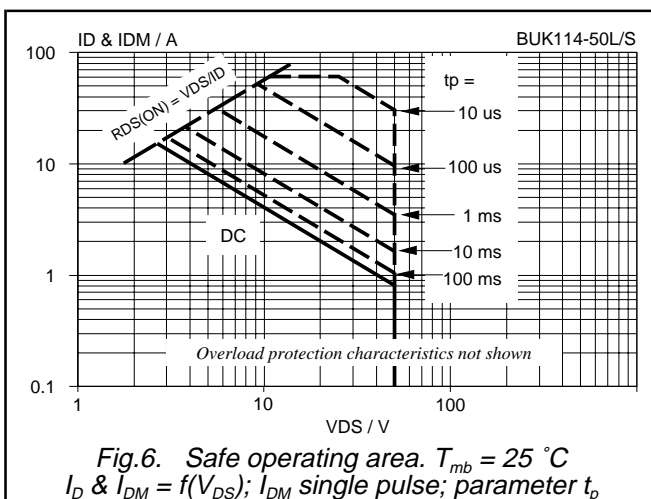
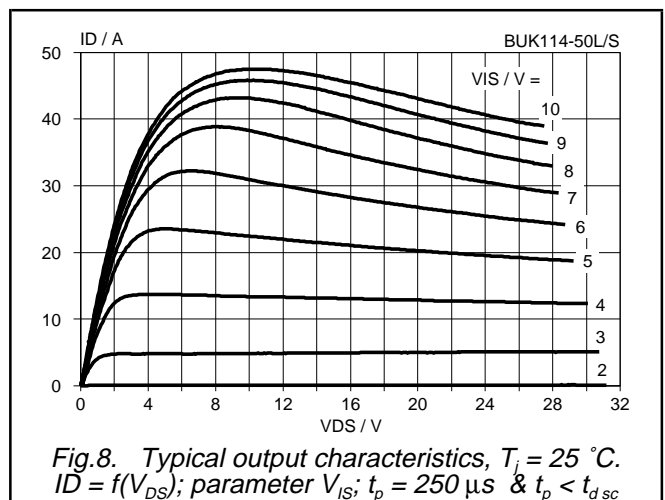
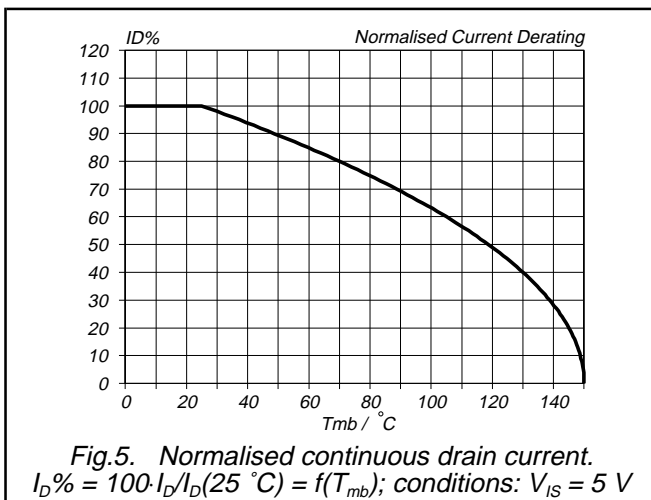
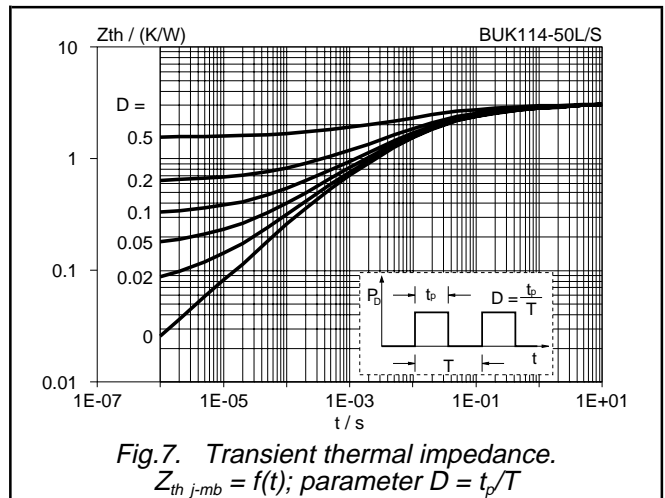
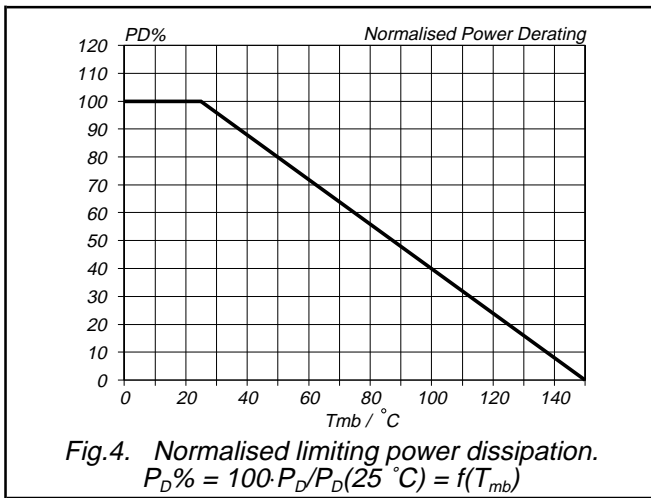

Logic level TOPFET  
SMD version of BUK104-50L/S

BUK114-50L/S

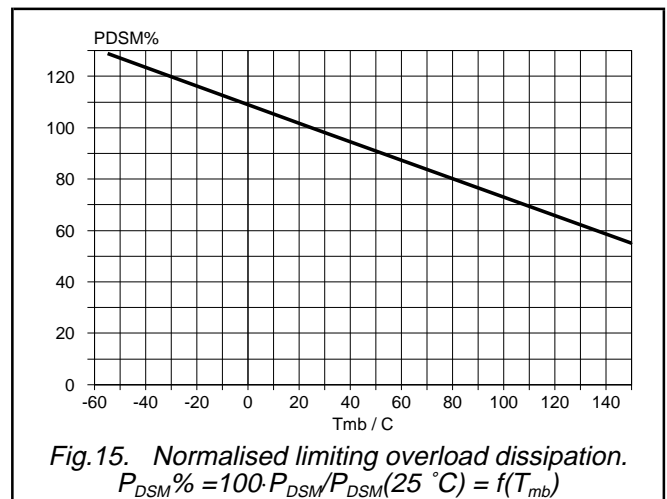
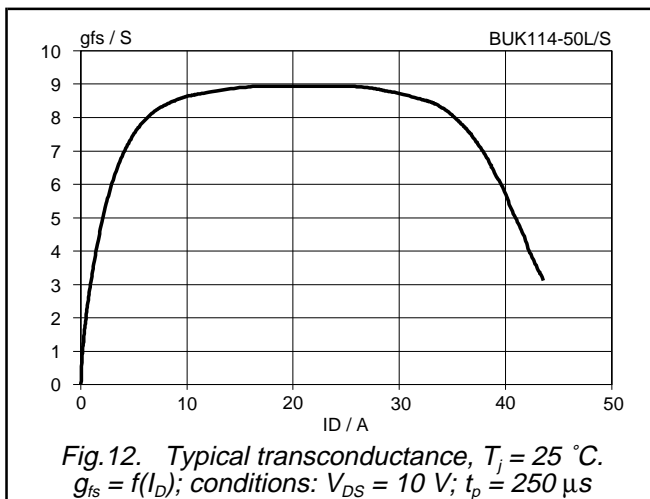
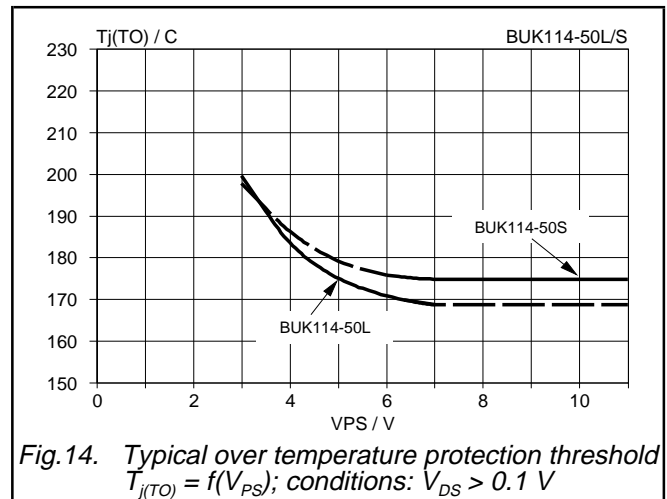
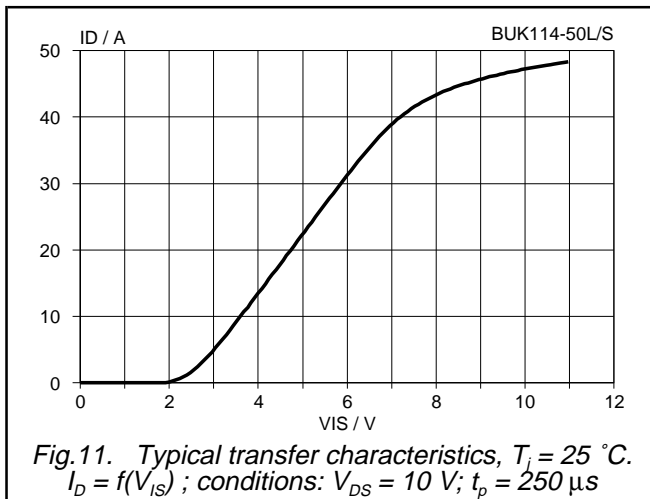
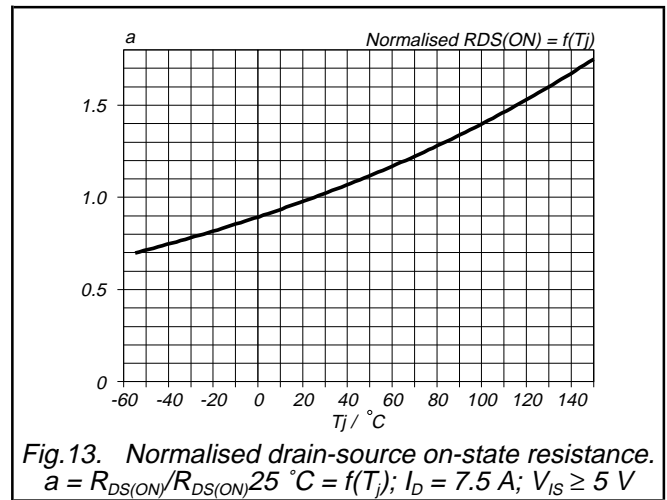
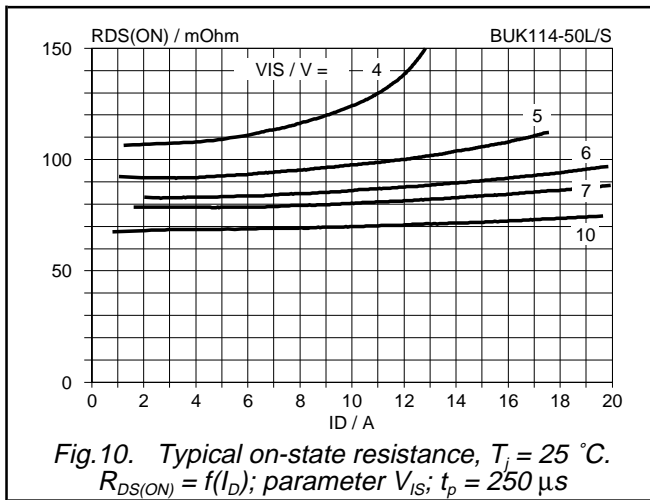



Logic level TOPFET  
SMD version of BUK104-50L/S

BUK114-50L/S

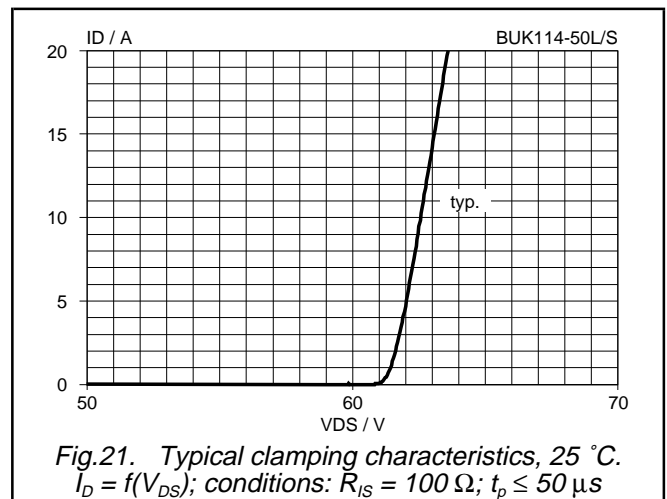
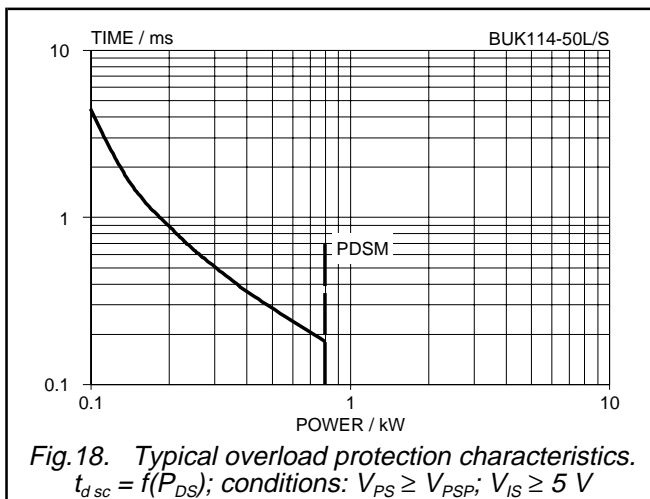
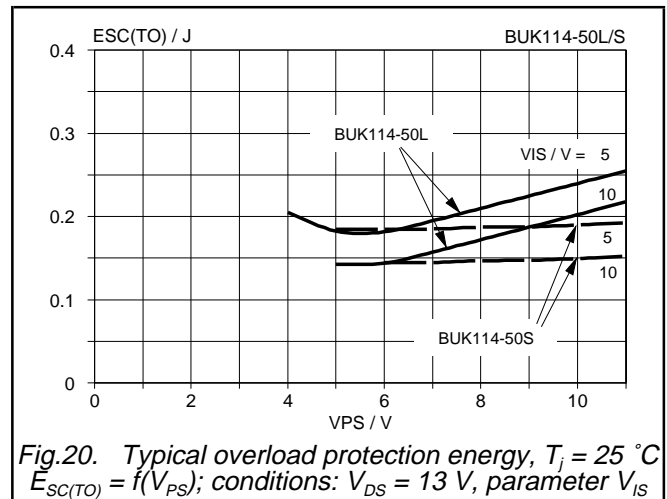
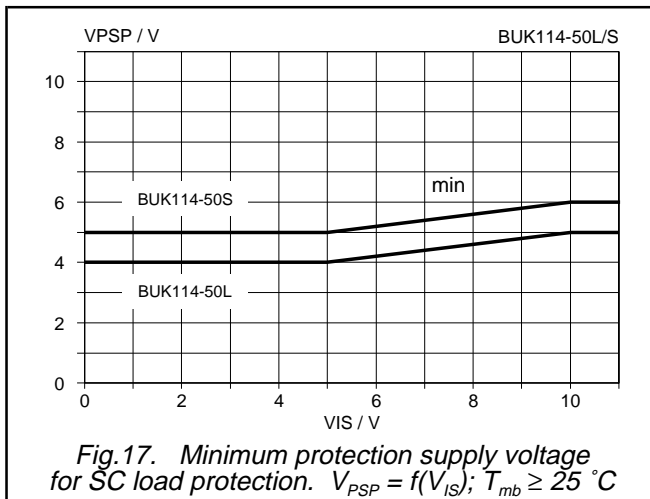
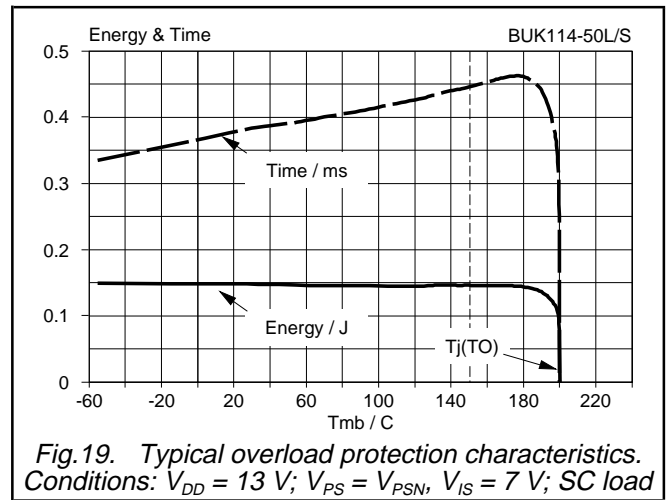
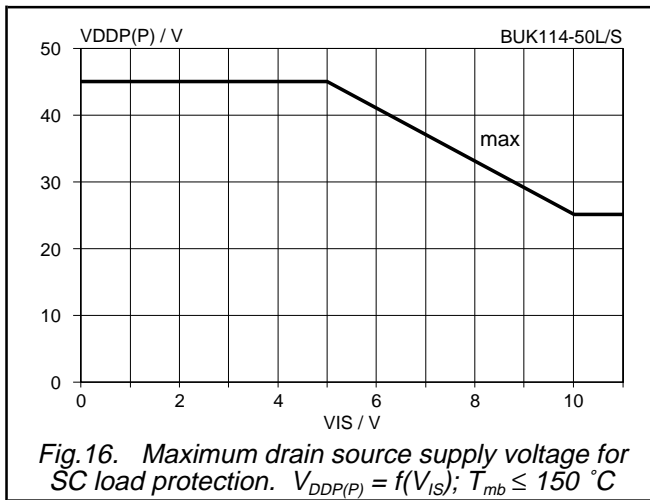

Logic level TOPFET  
SMD version of BUK104-50L/S

BUK114-50L/S

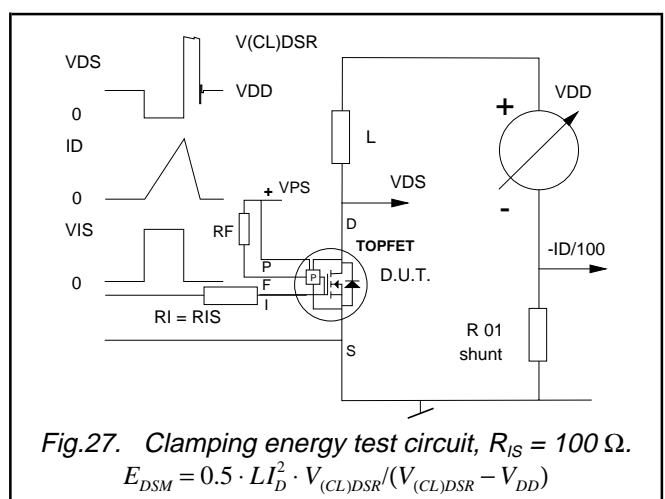
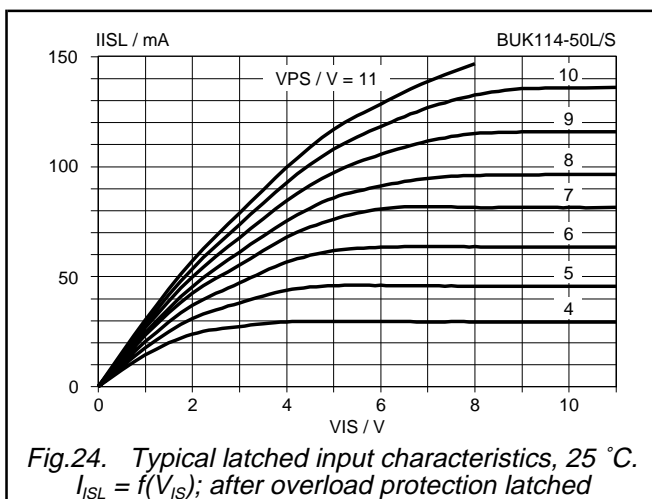
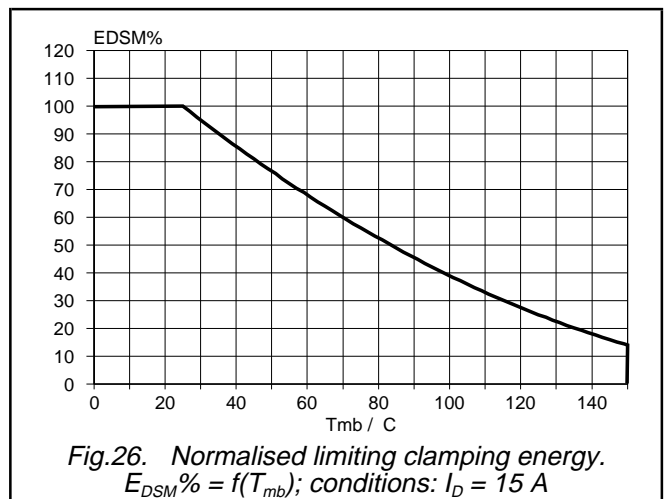
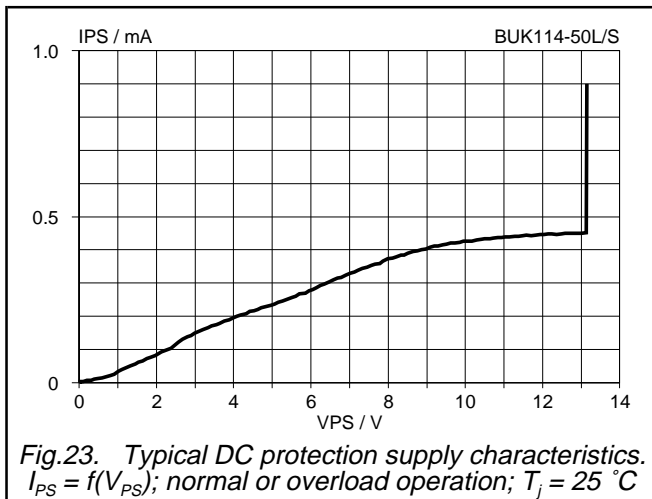
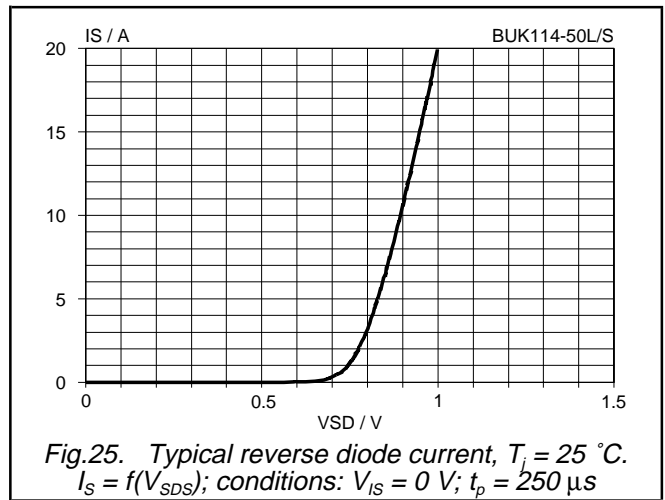
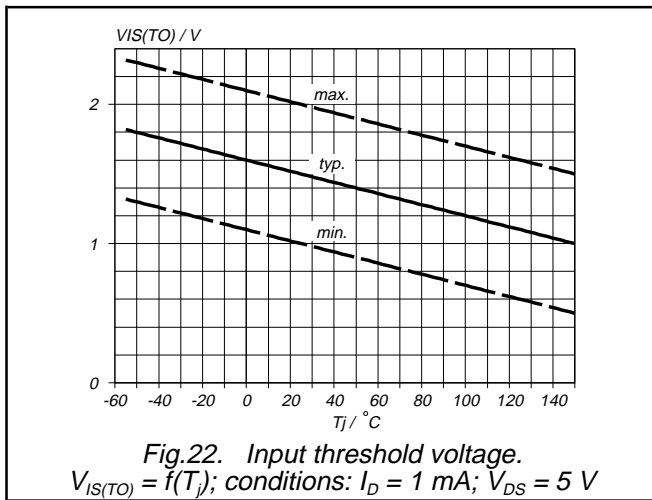

Logic level TOPFET  
SMD version of BUK104-50L/S

BUK114-50L/S

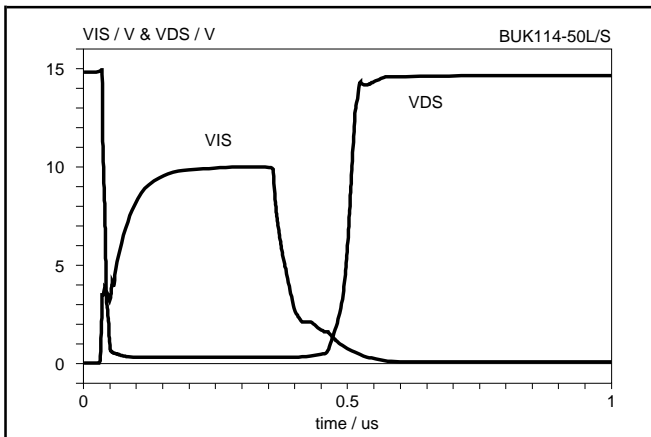

Fig.28. Typical resistive load switching waveforms  
 $R_I = R_{IS} = 50 \Omega$ ;  $R_L = 10 \Omega$ ;  $V_{DD} = 15 \text{ V}$ ;  $T_j = 25 \text{ }^\circ\text{C}$

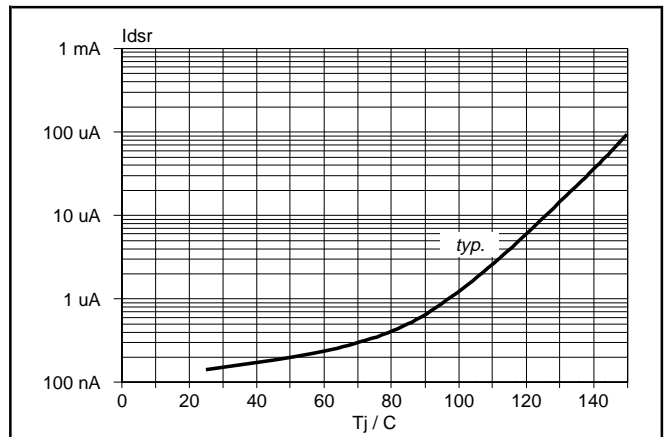

Fig.31. Typical off-state leakage current.  
 $I_{DSR} = f(T_j)$ ; Conditions:  $V_{DS} = 40 \text{ V}$ ;  $R_{IS} = 100 \Omega$ .

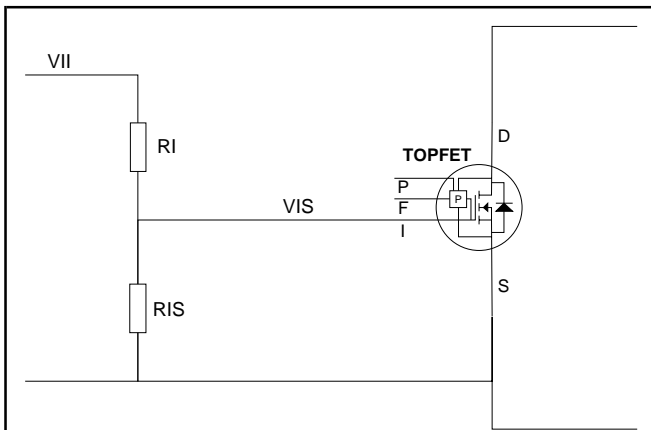

Fig.29. External input resistances  $R_I$  and  $R_{IS}$ , generator voltage  $V_{II}$  and input voltage  $V_{IS}$ .

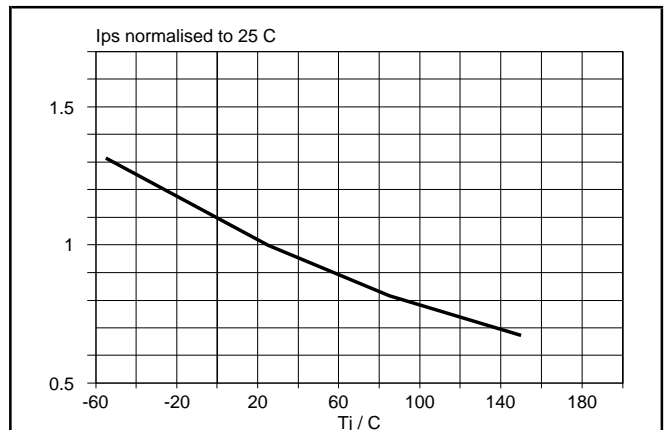

Fig.32. Normalised protection supply current.  
 $I_{PS} / I_{PS, 25^\circ\text{C}} = f(T_j)$ ;  $V_{PS} = V_{PSN}$

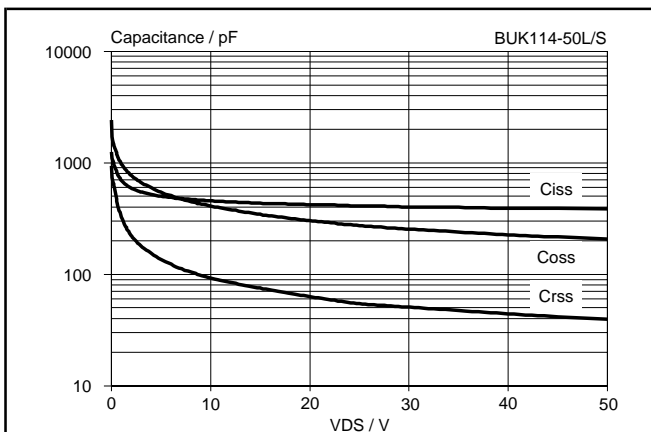
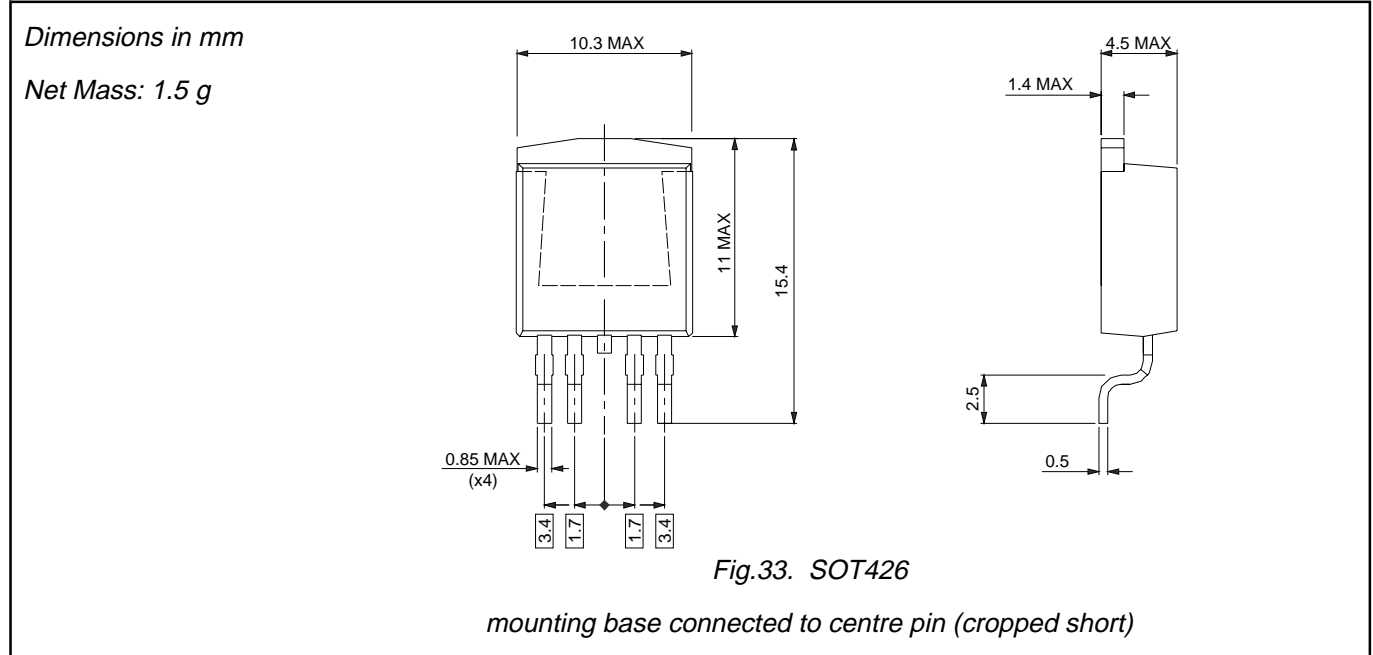

Fig.30. Typical capacitances,  $C_{ISS}$ ,  $C_{OSS}$ ,  $C_{RSS}$   
 $C = f(V_{DS})$ ; conditions:  $V_{IS} = 0 \text{ V}$ ;  $f = 1 \text{ MHz}$

Logic level TOPFET  
SMD version of BUK104-50L/S

BUK114-50L/S

**MECHANICAL DATA**



**MOUNTING INSTRUCTIONS**

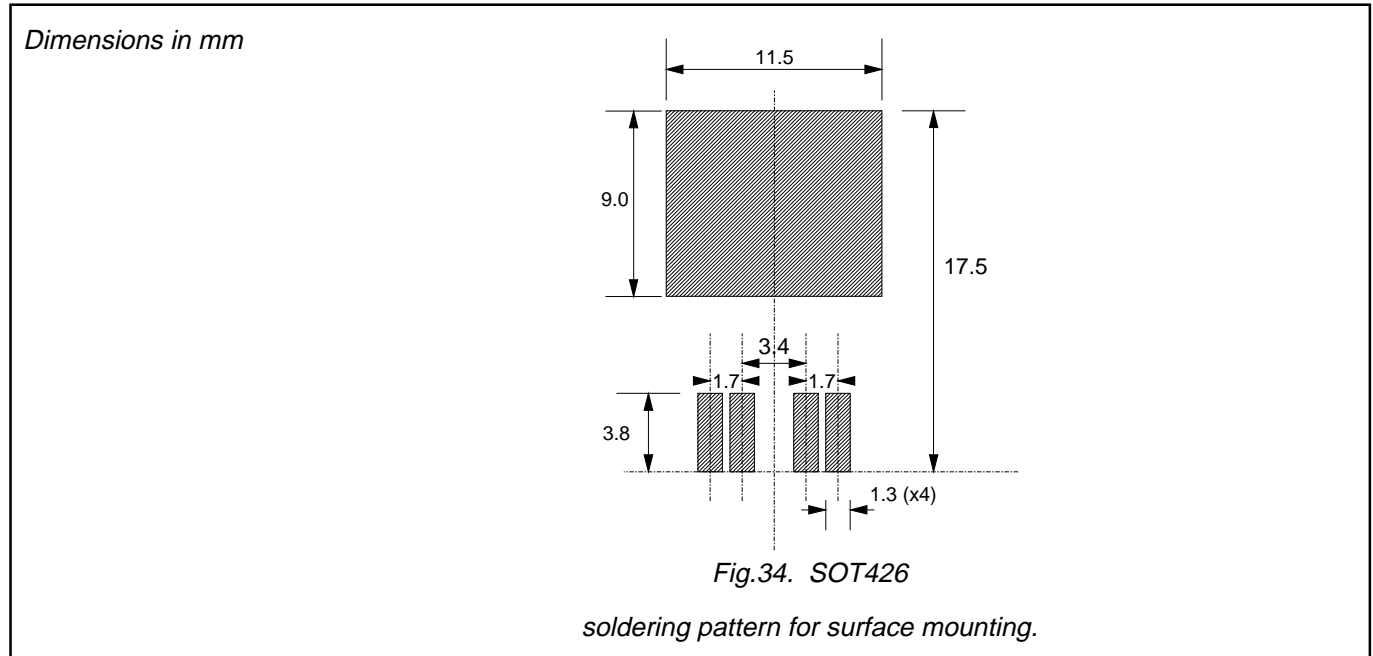

Logic level TOPFET  
SMD version of BUK104-50L/S

BUK114-50L/S

## DEFINITIONS

<b>Data sheet status</b>	
Objective specification	This data sheet contains target or goal specifications for product development.
Preliminary specification	This data sheet contains preliminary data; supplementary data may be published later.
Product specification	This data sheet contains final product specifications.
<b>Limiting values</b>	
Limiting values are given in accordance with the Absolute Maximum Rating System (IEC 134). Stress above one or more of the limiting values may cause permanent damage to the device. These are stress ratings only and operation of the device at these or at any other conditions above those given in the Characteristics sections of this specification is not implied. Exposure to limiting values for extended periods may affect device reliability.	
<b>Application information</b>	
Where application information is given, it is advisory and does not form part of the specification.	
© Philips Electronics N.V. 1996	
All rights are reserved. Reproduction in whole or in part is prohibited without the prior written consent of the copyright owner.	
The information presented in this document does not form part of any quotation or contract, it is believed to be accurate and reliable and may be changed without notice. No liability will be accepted by the publisher for any consequence of its use. Publication thereof does not convey nor imply any license under patent or other industrial or intellectual property rights.	

## LIFE SUPPORT APPLICATIONS

These products are not designed for use in life support appliances, devices or systems where malfunction of these products can be reasonably expected to result in personal injury. Philips customers using or selling these products for use in such applications do so at their own risk and agree to fully indemnify Philips for any damages resulting from such improper use or sale.